



INSTANT I-SOFT

A SOLID COMPREHENSIVE DOSING RANGE

Making feed water for you!

- Drinking water
- Process water
- Heating equipment
- Heat exchangers
- Air conditioners
- Cooling towers
- Boilers
- Steam boilers
- Membrane Systems
- Anti-Scalants

Protecting any Water Treatment System against

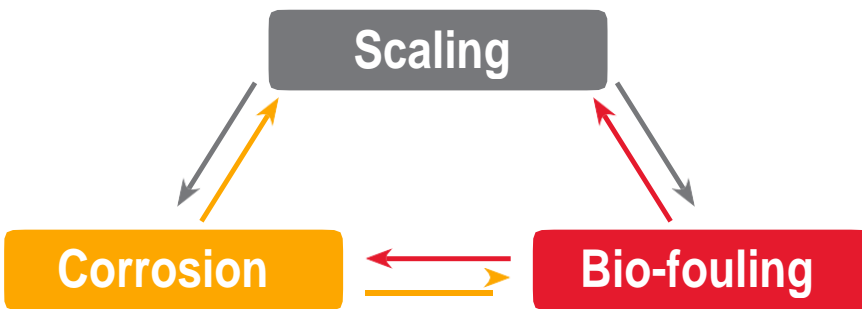

Advantage

- **Correct Dosing / Continuous Operation**
- **Controlled Concentration of products**
- **Personnel Safety**
- **Cost effectiveness**
- **Low Toxicity Technology**
- **Lower CO₂ Emissions**
- **100 % Recyclable Packaging**
- **Ease of Disposal**
- **Convenience**
- **No Service and Maintenance Costs**

Will you pay for the „water“ in the chemicals?

A 5 kg INSTANT bag makes 100 liters of dosing chemical



The difference between Instant Dosing Technology and other products is 95% less water and cost





WHY DOSING IS REQUIRED?

Sources of the major ions

Rain Water as it passes through the air and through and over the land, it dissolves many chemical species. Passing through the atmosphere, for example, it dissolves the gases which are the constituent of air including nitrogen, oxygen and carbon dioxide. The fact that it dissolves carbon dioxide from air is very important because when carbon dioxide is present in the water it forms carbonic acid and this acid enhances capability of the water to dissolve chemical species contained in rocks and soil.

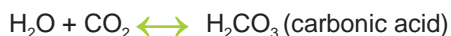

Which then enacts with Ca^{2+} , Mg^{2+} , Na^+ , Fe^{3+} , SO_4^{2-} , SiO_2^{2-} , Cl^-

Water become hard with

- Temporary Hardness
- Permanent Hardness

While passing through polluted atmosphere it is also possible for the water to dissolve gases associated with the pollution such as sulfur and nitrogen oxides.

Water becomes corrosive as some of these gases can make water very acidic, further adding to the water's ability to dissolve salts.

Ion Balancing

When a water quality sample has been analyzed for the major ionic species, one of the most important validation tests can be conducted:

The principle of electro neutrality requires that the sum of positive ions (cations) must be equal to the sum of the negative ions (anions). Thus the error in a cation-anion balance can be written as:

$$\text{balance error (\%)} = \frac{\sum \text{cations} - \sum \text{anions}}{\sum \text{cations} + \sum \text{anions}} \times 100 \text{ where the ions are expressed in meq/liter.}$$

For ground water and surface water the % error should be less than 10. If it is greater, the analysis does not pass the validation check.

Very important for the environment !

There is absolute need for ion exchange softeners, phosphates, phosphonates, EDTA and NTA to be replaced in many applications, because of issues concerning the effects of salt rejection and phosphorus compounds on aquatic life and water quality. All these products are **not biodegradable**.

Water Characterization

It is possible to characterize waters by performing a chemical analysis of the major ions. Once this is done the results can be plotted in a variety of formats to allow comparison between different waters. On the right side it shows how this can be done by means of bar chart for four different samples. The cations are plotted as the left half on the bar and the anions as the right half. The height of the graph represents the total concentration of major ions in the water in milli-equivalent per liter (meq/l).

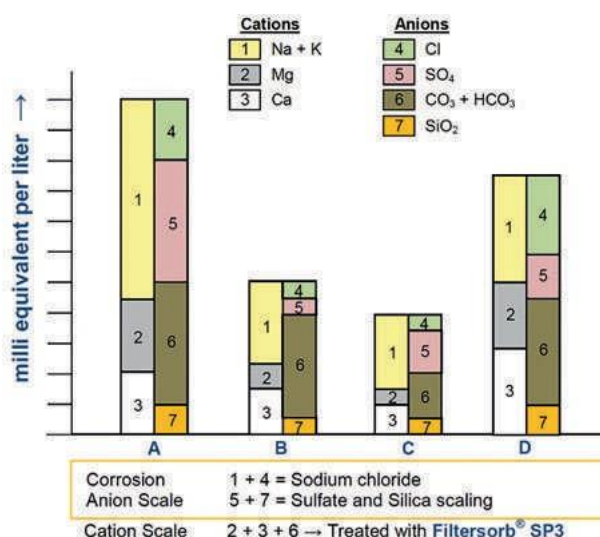



REASONS FOR CHOOSING I-SOFT

Will you pay for the „water“ in the chemicals?



A 5 kg **INSTANT** bag makes 100 liters of dosing chemical

- ✓ Correct Dosing/Continuous Operation
- ✓ Controlled Concentration of products
- ✓ Personnel Safety
- ✓ Cost effectiveness
- ✓ Low Toxicity Technology
- ✓ Lower CO₂ Emissions
- ✓ 100% Recyclable Packaging
- ✓ Ease of Disposal
- ✓ Convenience
- ✓ No Service and Maintenance Costs

2x 20 kg Instant chemical boxes can provide 800 liters of dosing chemical



Less product, less waste and maximum efficiency

For Water Treatment Optimization

- ✓ Reduces unnecessary Water Transport
- ✓ Prevents and reduces Handling costs

Watch Water® **INSTANT** Dosing Solutions and Technologies offers, Extensive chemical selection (Only a few selective formulations) for the entire Water Cycle with very small chemical consumption and reduced operating and maintenance costs



The best technology for End Users





SCALE CONTROL METHODS AND CONSEQUENCES:

There are only two methods of scale control commonly used in water chemistry.

- **Water softening or scale prevention and**
- **Antiscalant addition**

The prevention period for calcium carbonate is shorter than that for sulfate and silicate scales. These scales clog in pipes, heat exchangers, boilers, cooling towers and membrane elements, making the cleaning difficult and time consuming. These are a big risk that scaling will damage all equipment and membrane surfaces.

Sodium

All surface and ground water contains sodium ions (Na^+) as element is one of the most abundant on the planet. Very high concentrations in inland waters, however are normally associated with pollution from industrial water softeners, residential water softeners and in coastal areas, sea water intrusion. However, sodium and chloride concentrations in water is a major cause of **corrosion**. Thanks to the World Health Organization (WHO) to put maximum limit for Sodium (Na^+) in drinking water as 20 mg/lit (ppm).

Important:

When water is to be used for irrigation purposes it is important to know the sodium concentration as sodium have all negative effects on soil structure by de-flocculating it, which affect all plant growth.

Sulfate

The most common form of scale is calcium sulfate as gypsum ($\text{CaSO}_4 \cdot 2\text{H}_2\text{O}$) which is approximately 50 times more soluble than that of calcium carbonate (CaCO_3) at 37.7°C (100°F). Above 37.7°C (100°F) the solubility of Calcium sulfate decreases as the water temperature increases.

Important:

To prevent calcium sulfate scale, the sum of calcium concentration as (CaCO_3) and the sulfate concentration as (CaSO_4) must be less than 1 500 mg/l and their product should be kept below 500 000. But with I-SOFT treatment, the sum of calcium as sulfate (as CaSO_4) can be as high as 2 500 mg/l and their product should be less than 1 500 000. Calcium carbonate as crystals, present no scale problems as they can be blown down. So, no poly-phosphates or phosphonates should be used in cooling water, heat exchangers, boilers or any membrane application.

Phosphates

Phosphate contained products are all Phosphate's Chemical time Bombs



High concentration of phosphates in natural water or Poly-phosphates, phosphonates scale inhibitors always hydrolyze and revert to orthophosphates leading to deposition of calcium or iron phosphate scale. Since the solubility for calcium phosphate is very small. Temperature, pH, calcium and orthophosphate concentrations affect the formation of calcium phosphate. Calcium orthophosphates scale is more insulating than calcium carbonate and thus causes rapid heat transfer loss. **I-SOFT does not contain any phosphonates or phosphates.**

Phosphonates, Phosphates, EDTA and NTA

including water soluble polymers: ask for formulation from all other suppliers. They all use these **time bombs** to prevent calcium carbonate from precipitating and forming Scales. All these substances act by temporarily delaying the onset of crystallization.



I-SOFT is so much different



Because **I-SOFT** prevents salts from precipitating and forming scale and at the same time sequestering all metal cations.



RED-OXY TREATMENT
 FILTRATION
 ADSORPTION
 FILTERSORB
INSTANT PRODUCTS

WHAT IS INSTANT I-SOFT?

Watch Water® is the only producer of **INSTANT complexing Agent**. In addition to the **I-SOFT** (complex), we also offer **corrosion inhibitors, Biocides, Oxygen Scavengers, Cleaning agents, Descalers** and strong **Oxidizers** – and all of these products are **biodegradable!**

Watch Water® **does not supply Phosphates, EDTA, NTA, Phosphonates** or Complexing agents which are not Biodegradable.

The performance of the **I-SOFT Instant** type is much higher and the biggest advantage for customers is not to buy 95 % of expensive water, which involves higher transport costs and handling costs. It solves the problem of storage as well.

The excellent ecological properties of the **I-SOFT** have been confirmed by numerous customers worldwide. Watch Water® therefore recommends the **I-SOFT** as **replacement** for other, less environment friendly complexing agents, such as **Phosphates, Phosphonates, Ion-Exchange Cations, Anions and Silicates** etc.

- **I-SOFT** formulations are resistant of being broken down in the whole pH range between 2 to 14, even at elevated temperatures.

Specification	Mode of action
✓ Dispersing Agent	Dispersing agent such as I-SOFT is very effective to prevent the formation of scale such as barium sulfate.
✓ Scale Prevention	Displaces the equilibrium by sequestering all metal cations
✓ Corrosion Prevention	Strongly reduces the high concentrations of free metal ions to lower the solubility
✓ Stabilizing all OXIDIZERS, BIOCIDES and other chemicals	Sequesters all reactive heavy metals (iron, manganese, lead, copper, zinc etc.) and stops the reactivity of metal ions in the presence of oxidizers like HOCl, Chlorine, Chlorine dioxide, Bromine, Peroxides and Hydrogen Peroxide.

I-SOFT is a High Performance Complexing Agent against Permanent Water Hardness – Not cations but ALL SALTS!

Chemical Stability

Formulation's that contain **I-SOFT** as complexing agent remain chemically unchanged during transport, storage and dilution, in order to be able to deliver the full potential. This ensures that all Watch Water® formulations that contains **I-SOFT**, remain effective over long period of time.

pH Stability

- **I-SOFT** boosts the performance of highly alkaline formulations
- **I-SOFT** can easily be employed in all acidic formulations
- **I-SOFT** does not decompose even at extreme pH

Scale control

Watch Water® has introduced a revolutionary Scale control method to minimize the chemical use. Conventional ion-exchange resins add up sodium thus increasing the conductivity as well as making the water corrosive, which are undesired for all industrial applications.

The Watch Water® treatment method handles the water hardness load separately with the combination of **FILTERSORB SP3** and **I-SOFT** in series.





RED-OXY TREATMENT
 FILTRATION
 ADSORPTION
 FILTERSORB
 INSTANT PRODUCTS

STRONG ACID CATION SOFTENING VS. FILTERSORB SP3 SCALE PREVENTION INCLUDING I-SOFT

Here is an example table for complete Watch-Water Scale-Prevention Solution:

Hard Water contains salts of Cations and Anions	Water Hardness	Treatment Method
Ca^{2+} Mg^{2+} + HCO_3^-	Temporary / carbonate water hardness	Treated with FILTERSORB SP3 by converting the bicarbonates into nonsoluble carbonate crystals (Directed NAC)
Ca^{2+} Mg^{2+} Ba^{2+} Sr^{2+} + SO_4^{2-} SiO_2^{2-} PO_4^{2-} F^-	Permanent / noncarbonate water hardness	Treated by addition of I-SOFT for rest hardness stabilization and SOFT for corrosion control

When compared between softening and **FILTERSORB SP3**, the main disadvantage of softening is cost. When the sodium ions have been replaced by calcium and magnesium, the resin must be regenerated with sodium chloride. Expensive and complicated control valve is needed for backwash of the resin and required water to regenerate is huge in volume (see cost analysis).

The cost comparison does not include disposal costs for regeneration of the spent softener, which is becoming expensive all over the world. There is no level of hardness in which softening method can compete in economical aspect with **FILTERSORB SP3** and very little **I-SOFT** dosing to prevent sulfate and silica scales. **I-SOFT** is very surface active Antiscalant that interfere with precipitation reactions in three primary ways:

- Rest Hardness Stabilization
- Corrosion control
- Dispersion

I-SOFT formulation is an extremely effective sulfate scale inhibitor. It also has excellent Antiscalants qualities for silica scale and rest hardness stabilization for calcium carbonate. **I-SOFT** can be used in any surface or groundwater that contains

solids and silt. It also has high tolerance for oxygen scavengers and biocides.

Corrosion control

The **I-SOFT** stabilizes all polyvalent metal ions, which means that they can increase the rate at which the metals dissolve. Corrosion is decreased immediately if the pH is in the alkaline range and can be eliminated completely if **I-SOFT** contains Oxygen Scavenger as addition, both in Hot Water Boilers and Steam Boilers.

- **I-SOFT ON** – Non-volatile Oxygen scavenger
- **I-SOFT OV** – Volatile Oxygen scavenger

Both these **I-SOFT** types are in alkaline range, which is the optimum pH range for the boilers that stops corrosion, neutralizes any kind of hardness and saves all the cleaning with acids.

Advantages:

Solutions that contain **I-SOFT** are much less corrosive to aluminum if their pH is adjusted to 5 – 7. One of the biggest advantage to soften water and stop scale and corrosion is that **I-SOFT** contains a very low content of chlorides.





INSTANT I-SOFT FAMILY

form	Product Name		Function
	main	addition	
INSTANT	I-SOFT	-	<ul style="list-style-type: none"> • Municipal, Residential, Industrial, Commercial Water Application • Scale & Corrosion inhibitor for all pipes and equipments.
	I-SOFT	DW	<ul style="list-style-type: none"> • Drinking Water applications, Food & beverage Industries • Scale & Corrosion inhibitor for all pipes.
	I-SOFT	ON	<ul style="list-style-type: none"> • Scale & Corrosion inhibitor with Non-volatile Oxygen scavengers. • FDA approved multi-purpose Hot Boiler Water Treatment.
	I-SOFT	OV	<ul style="list-style-type: none"> • Scale & Corrosion inhibitor with Volatile Oxygen scavengers. • Multi-purpose Boiler (Steam Boilers) Water Treatment.
	I-SOFT	NB	<ul style="list-style-type: none"> • Cooling Water, Heat exchangers, Air conditioners • Multi-functional Scale and Corrosion inhibitor with Dispersant and non-oxidizing biocide for high silica and sulphate content in feed water.
	I-SOFT	OB	<ul style="list-style-type: none"> • Cooling Water, Heat exchangers, Air conditioners • Most effective non-hazardous oxidizing biocide in the market. High Cycle chemistry!
	I-SOFT	RO	Guaranteed one dosage and all prevention of scaling & fouling, such as silica, sulphate including barium and strontium scales.
	I-SOFT	ROB	Prevention of silica, sulphate, barium and strontium scaling and Bio-fouling.





RED-OXY TREATMENT
 FILTRATION
 ADSORPTION
 FILTERS ORB
 INSTANT PRODUCTS

Drinking Water and General Applications

INSTANT I-SOFT

INSTANT I-SOFT prevents precipitation of non-soluble salts and oxides on metal surfaces and keep the solids and the sludge in dispersion. Beside calcium carbonate, **INSTANT I-SOFT** is also a strong inhibitor for sulfates and silica scale. **I-SOFT** is environmentally friendly since does not contain phosphate, phosphonates, EDTA or NTA or any toxic chemicals and it is readily biodegradable.

Note: This product is not meant for direct human consumption.

APPLICATION:

Municipal, Residential, Industrial, Commercial Water Application Scale and Corrosion inhibitor for all pipes and equipments.

DOSING:

Standard Dilution: 20 liters of dosing solution is prepared from 1 kg of **INSTANT I-SOFT**

Feed rate: I-SOFT dosage ranges between 20 – 120 ml of diluted product against each cubic meter of water for water-hardness up to 600 mg/l (ppm).

I-SOFT is typically fed continuously in the make-up line or eventually directly into water circulation.

INSTANT I-SOFT DW

INSTANT I-SOFT DW is a food grade poly-mixture consisting of a mixture of Rest hardness and Anion scale stabilizer including a dispersant and sequester. It is specially designed to use in all potable (drinking) water applications. **INSTANT I-SOFT DW** contains all food grade are tested and certified by WQA to NSF/ANSI 60.

It brings high health risks for humans who drink water containing high sulfate levels. **INSTANT I-SOFT DW** form a corrosion inhibiting layer inside the pipes and all surfaces that comes in contact with the water. Because of its well-balanced composition, it inhibits the cathodic corrosion process, leading to a synergistic effect.

Anion Scale Inhibition: Ready to dose **I-SOFT DW** acts as "Threshold inhibitor" for sulfate and silica scale, thus stabilizing the anion hardness scale. As a guideline **I-SOFT DW** prevents sulfate and silica scale up to 500 mg/l (ppm) in water. The temperature of the water can be up to 90°C.

APPLICATION:

Food grade multipurpose potable (drinking) water treatment

DOSING:

Standard Dilution: 5 % strength dosing solution is prepared from 1 kg of **INSTANT I-SOFT DW** in 20 liters of water.

Feed rate: Fed with a dosing rate of 40 – 60 ml/m³ (proportional to 2 – 3 mg/l) for drinking water. Dosing rate may vary depending upon the water quality.

Corrosion Inhibition by **INSTANT I-SOFT DW**: Sulfate is one of the major dissolved component of drinking water. High concentration of sulfate in the water we drink can have a Laxative effect. Bacteria which attack and reduce sulfates, form hydrogen sulfide (H₂S). Hydrogen sulfide gas can cause the maximum corrosion and to avoid both calcium and magnesium bicarbonates and sulfates and silica anion scales including chlorides corrosion **INSTANT I-SOFT DW** is the best effective and economical solution.





Hot Water Boiler Applications

INSTANT I-SOFT ON

INSTANT I-SOFT ON is an instant boiler water powder incorporation with multi-function scale inhibitor and an Corrosion and alkalinity builders which also includes Oxygen scavenger.

This product is suitable to dose under both softened water and **FILTERSORB SP3** treated make-up water applications.

Note: This product is not meant for direct human consumption. Industrial use only.

APPLICATION:

Scale and Corrosion control with Non-volatile Oxygen Scavenger
 Hot Water Boiler Water Treatment

DOSING:

Standard Dilution: 20 liters of dosing solution is prepared from a 1 kg of **INSTANT I-SOFT ON**

Feed rate: **I-SOFT ON** dosage ranges between 20 - 120 ml of diluted product against each cubic meter of water for water-hardness up to 600 mg/L (ppm).

I-SOFT ON is typically fed continuously in the make-up line or eventually directly into water circulation.

Note: This is only an Example. Values Indicated here must not be the actual control parameters for a real system

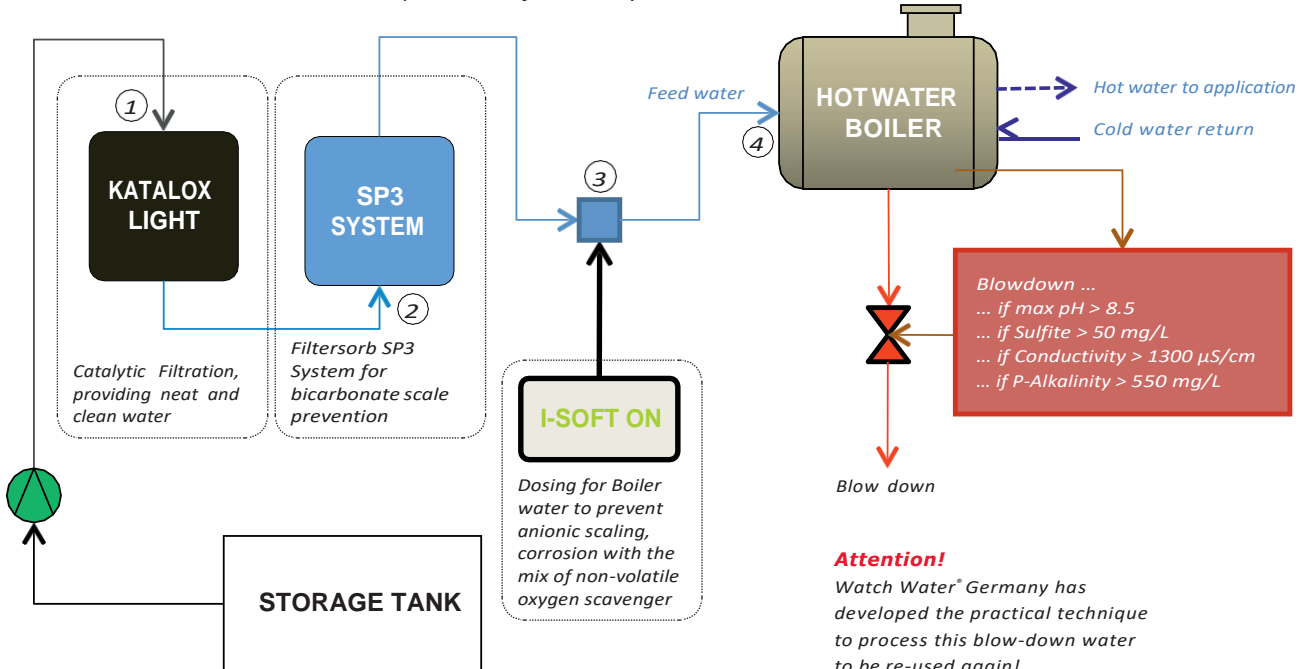

BBT: Best Boiler-water Treatment





Steam Boiler Applications

INSTANT I-SOFT OV

(Based on CHZ technology)

INSTANT I-SOFT OV is an instant boiler water oxygen scavenger. **INSTANT I-SOFT OV** is based on CHZ and is formulated to remove dissolved oxygen from boiler water. This is the first hydrazine substitute designed to provide a product that acts like hydrazine but does not contribute any hazardous byproducts. The product has a patent (#429717) for use as an oxygen scavenger.

I-SOFT provides excellent metal Passivation. In the presence of heat and a very special formulation of **INSTANT I-SOFT OV** it breaks down to form neutralizing amines which elevate the pH of the condensate systems, helping to protect it from

APPLICATION:

Scale and Corrosion control with Volatile Oxygen Scavenger Steam Boiler Water Treatment

DOSING:

Standard Dilution: 20 liters of dosing solution is prepared from 1 kg of **INSTANT I-SOFT OV**

Feed rate: **I-SOFT OV** is generally dosed at the rate of 56 ml of 5% strength diluted solution in each cubic meter of water (per 1000 liters) for each 1 mg/l of Oxygen.

any gaseous attacks. **I-SOFT** as usual protects from scale, corrosion and keep all impurities in dispersion. CHZ does not add any dissolved solids to the system. Feed water from **FILTERSORB SP3** keeps all sodium away for corrosion attack.

Note: This product is not meant for direct human consumption. Industrial use only.

Note: This is only an Example. Values Indicated here must not be the actual control parameters for a real system

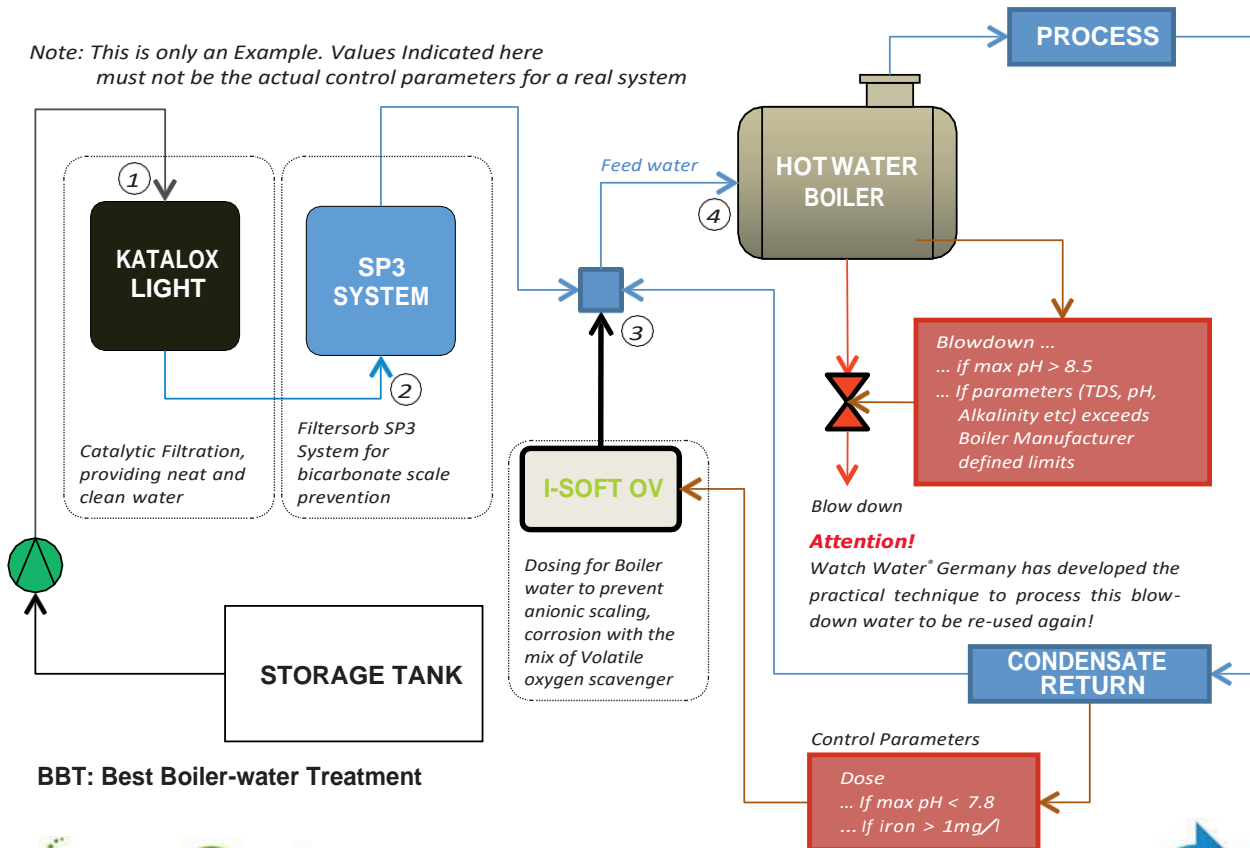

BBT: Best Boiler-water Treatment





Cooling Water Treatment INSTANT I-SOFT NB

Multi-functional scale and corrosion inhibitor with dispersant and **non-oxidizing biocide**. Perfect for water containing very high sulfates and silica. To protect inner wall of pipes made of copper or other metals from corrosion, it contains tolyltriazole. It is formulated with one of the best fast acting non-oxidizing biocide available in the water treatment industry. This biocide has outstanding environmental properties because it is non-persistent and degradable to naturally occurring products. **INSTANT I-SOFT NB** uses most advanced polymer anti-scalant and dispersant and tolyltriazole as corrosion inhibitor.

INSTANT I-SOFT OB

Stabilized oxidizing biocide in **INSTANT I-SOFT OB** is much stronger with the oxidation potential 1.8, than Chlorine (Cl₂) and Chlorine dioxide (ClO₂) which have the oxidation potential 1.36 and 0.96 respectively.

Completely water soluble, **INSTANT I-SOFT OB** is an instant powder which can effectively destroy bacteria, Legionella in just seconds. In fact, all cooling towers are polluted with Legionella and its one of the biggest application point of **INSTANT I-SOFT OB**. The recommended amounts are small as it is very concentrated.

Note: This is only an Example. Values Indicated here must not be the actual control parameters for a real system

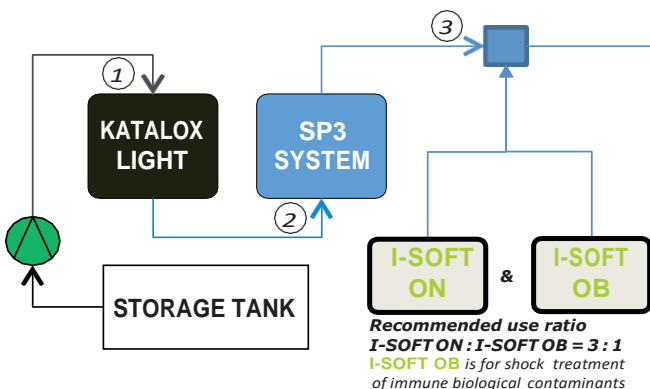

APPLICATION:

Cooling water, Air Conditioners and Heat exchanger
 Scale and Corrosion control with bio-fouling prevention

DOSING:

Standard Dilution: 20 liters of dosing solution is prepared from 1 kg of **INSTANT I-SOFT NB**

Feed rate: **INSTANT I-SOFT NB** is generally dosed at the rate of 50 ml/m³ of feed water to prevent silica and sulfate scale. **I-SOFT NB** has shown best results and no scale up to 300 mg/l (ppm) of silica in feed water. No extra biocide is required as it contains very powerful non-oxidizing biocide which is 100 % biodegradable.

APPLICATION:

Cooling water, Air Conditioners and Heat exchanger

DOSING:

Standard Dilution: 20 liters of dosing solution is prepared from 1 kg of **INSTANT I-SOFT OB**

Feed rate: **INSTANT I-SOFT OB** is generally dosed at the rate of 100 ml/m³ of feed water. 5 kg **INSTANT I-SOFT OB** can make 100 liters of scale, corrosion inhibitor, dispersant and strong oxidizing biocide. After the dilution is made it can be dosed till the container is empty to start again with **INSTANT I-SOFT OB**. It should be regulated to 3:1; three containers of **INSTANT I-SOFT NB** and one container of **INSTANT I-SOFT OB** alternatively to provide shock treatment to the biology which might get immune to the non-oxidizing biocide. No other equipments or chemicals are required.

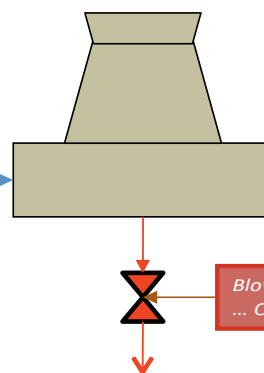

BCT:
Best Cooling-water Treatment

Attention!

Watch Water® Germany has developed the practical technique to process the cooling tower blow-down water (patent filed) to be re-used again!



RED-OXY TREATMENT

FILTRATION

KATALOX LIGHT
CRYSTOLITE

ADSORPTION

CATALYTIC CARBON
TITANSORB
FERROLOX

FILTERSORB

FILTERSORB SP3
SPECIAL FILTER

INSTANT PRODUCTS

ISOFT CHEMICALS
OXYDES
OXYSORB
BIOXIDE
SCALE-OVER
GREEN-ACID



Membrane Water Treatment

Note: This is only an Example. Values Indicated here must not be the actual control parameters for a real system

BRT: Best RO-water Treatment

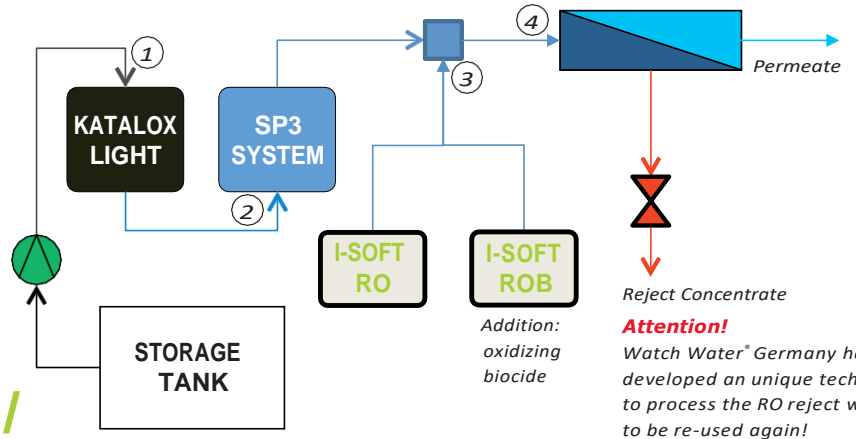

INSTANT I-SOFT RO/ INSTANT I-SOFT ROB

The revolutionary Antiscalant and Corrosion Prevention **INSTANT I-SOFT RO** powder (**INSTANT I-SOFT ROB** for added **oxidizing biocide**) is used for large systems with first and second pass, partial recycling, small and medium Reverse Osmosis (RO) systems for potable use. Treats water with very high Silica and all kinds of sulfates. It has no phosphates or phosphonates to avoid eutrophication and it contains 100 % environment friendly chemicals.

No formulation compound has bioaccumulation tendency.

INSTANT I-SOFT RO is the only Antiscalants which is dosed for high silica and sulfate scales and you would never need cleaning. We have the right product for Membranes and pure water.

APPLICATION:

Scale and Corrosion prevention for Membranes
Membrane treatment for sea water, Brackish water including concentrate recycle.

DOSING:

INSTANT I-SOFT RO and **INSTANT I-SOFT ROB** are generally dosed at the rate of 10 – 40 ml/m³ (v/v) from diluted (5 %) **I-SOFT ROB**.

Important:

INSTANT I-SOFT RO/ROB – 5 % strength solution is metered in a ratio of 10 ml/m³ for concentrations of TDS up 2000 mg/l (ppm)

**Why scaling of Silica, Calcium Sulfate (gypsum), Calcium phosphate, Magnesium hydroxide, Barium sulfate (barite) or Strontium sulfate is noticed on membrane surfaces?
Why you should never again need to clean your membrane?**

Please ask the Watch Water® Team We are leaders in our field membranes.

No more 100 different Dosing Solutions but One and the Only One family of **INSTANT I-SOFT® RO/ROB**

To know and learn more about this huge potential of **I-SOFT** Chemicals please contact us: